

96W MAGNETIC LOW VOLTAGE DIMMABLE DRIVER

DR-96W-24VDC-DIM



Description

The 96W Magnetic Low Voltage Dimmable Driver is an excellent solution for residential applications. It is equipped with two auto-reset breakers, one on the input and one on the output, which protect both the load and driver. The driver is encased in a coated metal box that includes 2 knock-outs, one on each side, to enable easy installation that complies with electrical code requirements.



DIMMABLE

24V DC

Class 2



Specifications

Input Voltage	120V AC	Input Current Full Load	0.96A
Output Voltage	24V DC	Output Voltage Full Load	22.2V DC
Max Load	96 Watts	Max Output Current Full Load	4.31A
Absolute Min. Load	48 Watts	Open Circuit Output Voltage	24.6V DC
Max Operating Temp. *	160°F (71.1°C)	Dimensions LxWxH	6-9/16" x 2-9/16" x 2-1/4"
Avg. Efficiency	85%	Weight	3 lbs. 2 oz.
Dimming	MLV **	Ratings	ETL Listed, Class 2, and NEMA-3R
Circuit Breaker	Primary & Secondary Auto-Reset	Warranty	5 Year Limited

*When installed with proper ventilation.

**See our Dimmer Compatibility List for a complete list of compatible dimmers (pg. 2-3).

Features

- Dimmable with most quality magnetic low voltage dimmers
- Compact design
- NEMA-3R enclosure for outdoor use
- Two knock-outs for simple installation
- Class 2 compliant
- ETL Listed

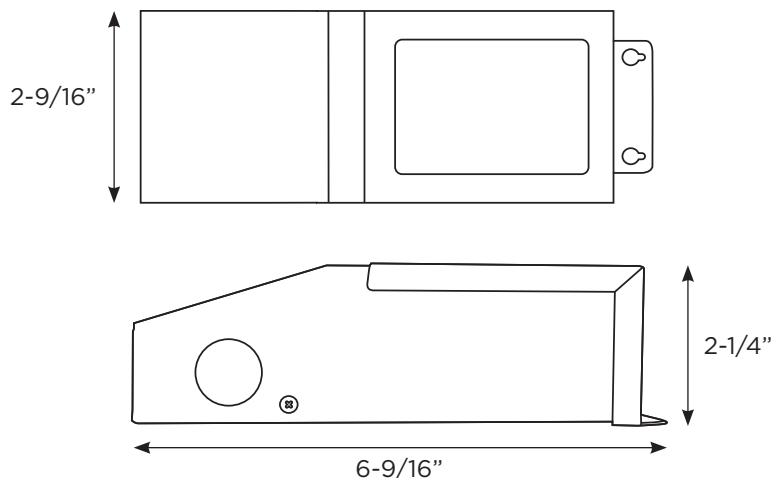

DIMMER COMPATIBILITY LIST

FOR DIMMABLE MAGNETIC LOW VOLTAGE DRIVERS



Lutron Dimmers

Lutron Aycl

153-PH

Lutron Ariadni

AYLV-600P

AYLV-600P-CSA

AYLV-600P-S

AYLV-603P

AYLV-603P-CSA

AYLV-603P-S

Lutron Diva

DVLV-103P

DVLV-603P

DVSVCLV-103P

DVSVCLV-603P

DVLV-103P-CSA

DVLV-603P-CSA

DVLV-103P-S

DVLV-603P-S

DVLV-103PH-S

DVLV-603PH-S

DVSVCLV-103P-L

DVSVCLV-603P-L

DVLV-10P

DVLV-600P

DVSVCLV-10P

DVSVCLV-600P

DVLV-10P-CSA

DVLV-10P-S

DVLV-10PH-S

DVSVCLV-10P-L

DVLV-603V

SC-1PS

SC-3PS

SC-4PS

SC-1PSNL

SC-3PSNL

SC-4PSNL

Lutron Nova

NTLV-600

NTLV-1000

NTLV-1500

NTLV-600-S

NTLV-1000-S

NTLV-1500-S

NTLV-603P

NTLV-1003P

NTLV-1503P

NTLV-2003P

NTLV-603P-CSA

NTLV-1003P-CSA

NTLV-1503P-CSA

NTLV-603P-S

NTLV-1003P-S

NTLV-1503P-S

NTLV-2003P-S

NT-1PS

NT-1PS-CSA

NT-1PS-S

NT-3PS

NT-3PS-CSA

NT-3PS-S

NT-4PS

NT-4PS-CSA

NT-4PS-S

Lutron Skylark

SLV-600P

SLV-600P-CSA

SLV-600PH-CSA

SLV-603P

SLV-603P-CSA

SLV-603PH-CSA

Lutron Lyneo

LXLV-103PL

LXLV-603PL

LXLV-10PL

LXLV-600PL

Lutron Vareo

V-600

V-1000

V-600-S

V-1000-S

VETN-1000

VETS-1000

VETS-1000-CSA

VETN-1000-S

VETS-1000-S

VETS-R

VETS-R-S

VETS-1000-SL

VETS-1000-SL-S

VETS-A-SL

VETS-A-SL-S

Lutron Nova T

NTLV-600

NTLV-600-277

NTLV-1000

NTLV-1000-277

NTLV-1500

Lutron Glyder

GLV-600

GLV-600-CSA

Lutron RadioRA2

RRD 10 ND

Lutron Ceana

CNLV-600P

CNLV-603P

Lutron Homeworks RF Maestro

HRD-6ND-XX 600 W Incandescent/MLV Neutral Wire Dimmer

HRD-10ND-XX 1000 W Incandescent/MLV Neutral Wire Dimmer

Lutron Maestro

NOTE: THE FOLLOWING LUTRON MAESTRO DIMMERS DO NOT WORK WITH THE DIMMABLE MLV DRIVERS:

MALV-600

MALV-1000

MSCLV-600M

MSCLV-1000M

MACL-153M

Legrand Dimmers

Legrand Wireless Universal

DRD4-W

DRD4-A

DRD4-B

DRD4-I

Legrand Pass & Seymore

HLV1103PW

CDLV1103PW

HLV703PTC

WSLV703PW

H703PTUTC

CDLV703PW

LSLV600PW

LSLV600W

Have questions about a dimmer not listed? Contact our design department at 832-717-2710 or designs@ledinspirations.com.

DIMMER COMPATIBILITY LIST

FOR DIMMABLE MAGNETIC LOW VOLTAGE DRIVERS



Leviton Dimmers

Leviton Mural

MDM06-1LI
MDM06-1LW
MDM06-1LA
MDM10-1LI
MDM10-1LW
MDM10-1LA

Leviton SureSlide

6613-PLT
6613-PLI
6613-PLW
6613-PLA

Leviton Illumatech

IPM06-1LZ
IPM06-1LX
IPM10-1LZ

Leviton ToggleTouch

TGM10-1LI
TGM10-1LA
TGM10-1LT

Leviton Vizia

VPM06-1LZ

Crestron Dimmers

Crestron Dimmers

CLS-C6(M)
CLS-EXP-DIM
CLS-EXP-DIMU
CLX-1DIM4
CLX-1DIM8
CLX-2DIM8
DIN-1DIM4
CLW-DIMSWEX
CLW-DIMSWCN
CLW-DIMEX
CLW-DIMCN
P-DIMEX
GLX-DIM6
GLXX-2DIM8

Control4 Dimmers

Control4 Dimmers

Control4 120V Wireless
Dimmer C4-DIMIZ

Vantage Control Dimmers

Vantage Control

SDM12-EM

Savant Systems Dimmers

Savant Systems

8 Channel Dimmer Module LMD-8120

Have questions about a dimmer not listed? Contact our design department at 832-717-2710 or designs@ledinspirations.com.