

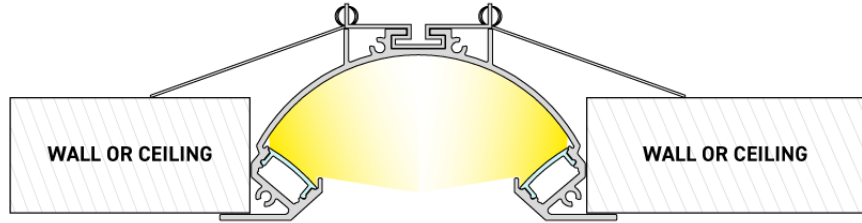

# Inspire Recessed Indirect

Preliminary specification. Information subject to change without notice.

Type	
Part No.	
QTY	
Signature	

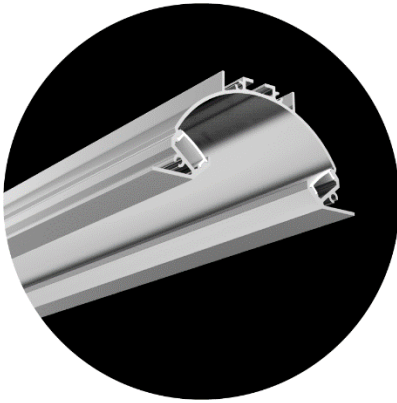

## Specifications

<b>Lens Type</b>	Frosted
<b>Channel Finish</b>	Anodized Aluminum and Custom Colors
<b>Compatible LED Tape Light</b>	Two (2) strips of: - Inspire V5 Spec 1.5, 2.8, 5.0, and 7.5 - Inspire LightLine™ COB 1.5, 2.8, and 5.5
<b>Mounting</b>	Recessed

## Part Numbers

Part Number	Description	Ordering
<b>CH1-KIT-INDL-2M</b>	Inspire Recessed Indirect Channel Kit. Anodized aluminum finish. 2m (6.56 FT). Includes channel, (2) frosted lenses, (4) end caps with screws, and (5) mounting clips with screws.	Per piece
<b>CH1-INDL-CUSTOM</b>	Custom length Inspire Recessed Indirect Channel. Includes channel, (2) frosted lenses, (4) end caps with screws, and (5) mounting clips with screws.	Per foot
<b>CH1-END-INDL</b>	Extra End Cap set for Inspire Recessed Indirect Channel. Includes (2) end caps with screws.	Per set
<b>CH1-MNT-INDL</b>	Extra Mounting Clip set for Inspire Recessed Indirect Channel. Includes (5) mounting springs with screws.	Per set

## Dimensions

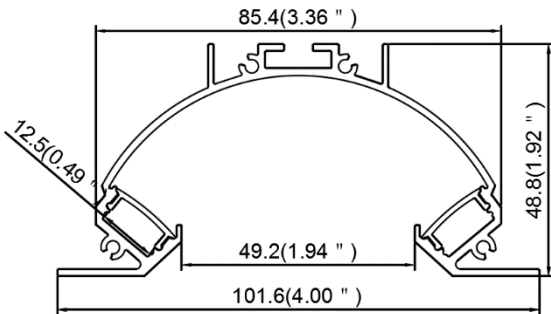



# Inspire Recessed Indirect

Preliminary specification. Information subject to change without notice.

Type	
Part No.	
QTY	
Signature	

## Installation

1) Install both strips of the LED tape light.

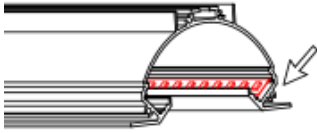

2) Install both lenses.

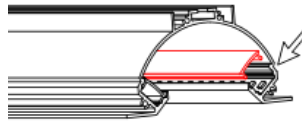

3) Slide the mounting springs into the slot on the back of the channel.

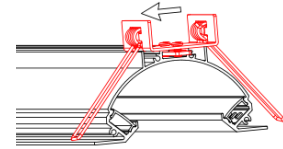

4) Screw the mounting springs into place.

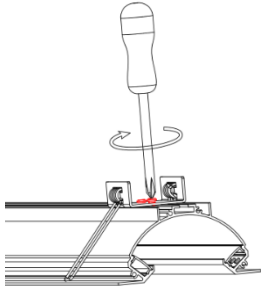

5) Install the end caps.

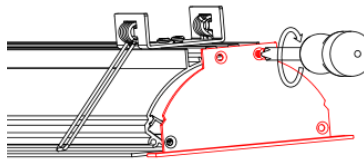

6) Pull the mounting springs back and insert the fixture into the recessed slot.

